

M62 EYEPIECE HOLDER TUBE & EYEPIECE

STANDARD ROTATABLE C-MOUNT

T-2 ADAPTER

ORIENTABLE C-MOUNT

STANDARD C-MOUNT

ARRI PL ADAPTER

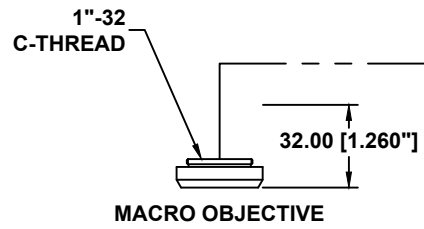
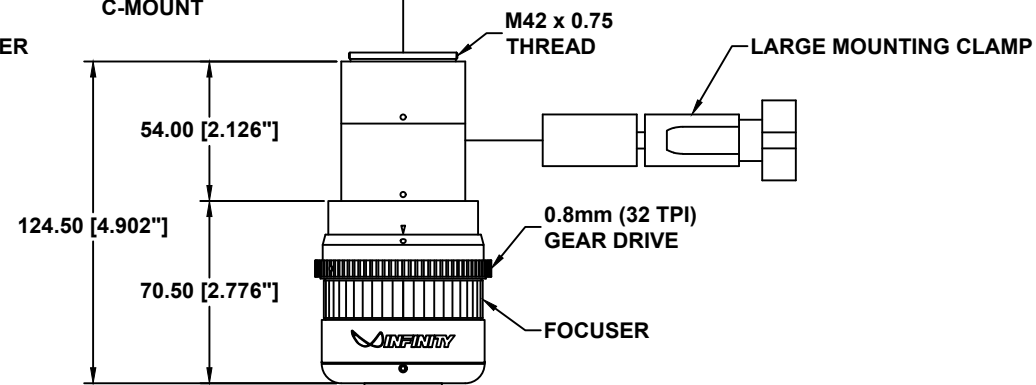

MACRO OBJECTIVE

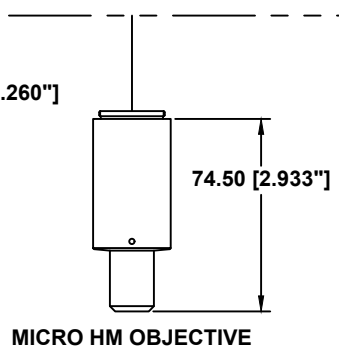

MICRO HM OBJECTIVE

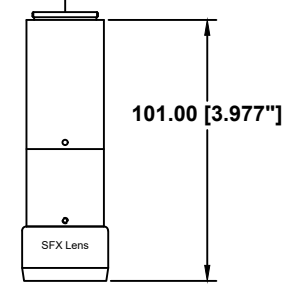

SFX LENS

REVISIONS				
ZONE	REV	DESCRIPTION	DATE	APPROVED

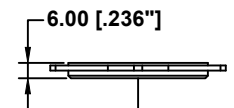
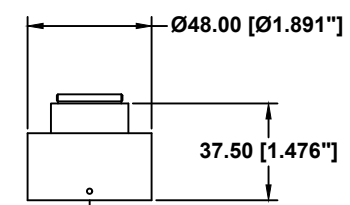

This drawing is for informational purposes only. No other rights or privileges are granted or implied.

ALL DIM ARE mm [inches] AND ARE FOR REFERENCE ONLY AND ARE SUBJECT TO CHANGE.		 INFINITY Photo-Optical Company www.infinity-usa.com		
INFINIPROBE ROBUSTO				
Date: 03/12/18 MB	SIZE B	FSCM NO.	DWG NO. -	REV -
Modified:	SCALE NONE	-	SHEET 1 OF 1	