

PROXIMITY SERIES:

InfiniGage™

The Gaging Lens

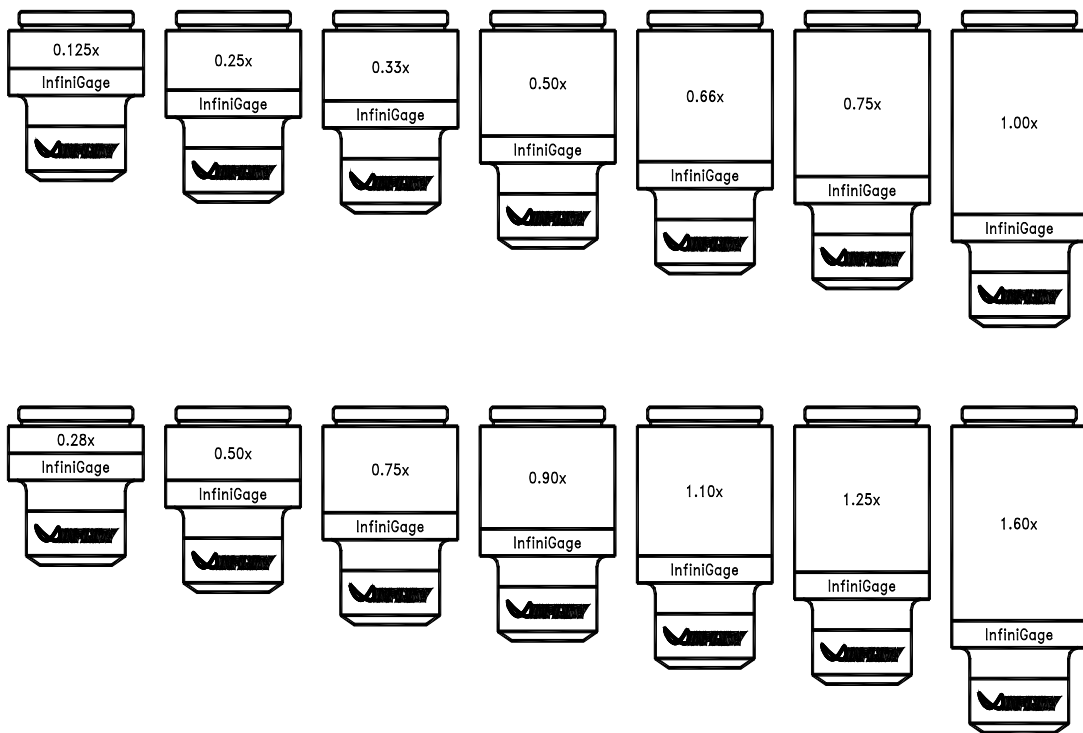

 **INFINITY** Photo-Optical Company • Manufacturers of precision optical instruments.

7108-D S. Alton Way., Centennial, CO 80112 • Tel: (303) 440-4544 • Fax: (303) 440-4144 • E-mail: info@infinity-usa.com • Web: www.infinity-usa.com

Copyright 2021 Infinity Photo-Optical Company. All Rights Reserved.

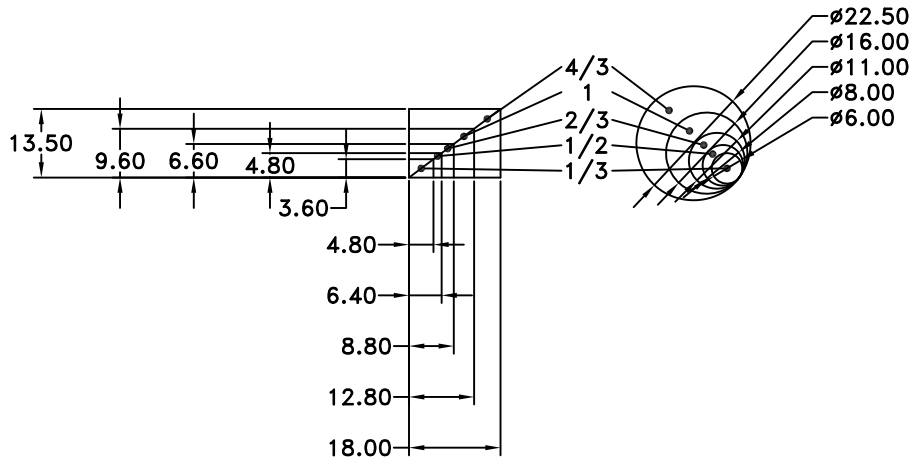

REVISIONS				
ZONE	REV	DESCRIPTION	DATE	APPROVED

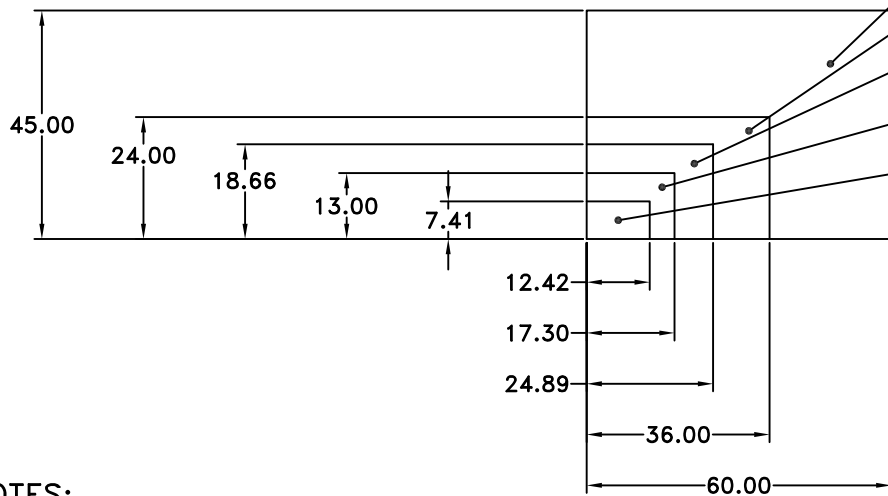

NOTES:
1. SENSOR SIZE & IMAGE CIRCLE
IN MILLIMETERS.

ALL DIM ARE mm
[inches] AND ARE FOR
REFERENCE ONLY AND
ARE SUBJECT TO
CHANGE.

INFINITY Photo-Optical Company
www.infinity-usa.com

SENSOR SIZE AND IMAGE CIRCLE

Date: 08/27/21 MB	SIZE B	FSCM NO.	DWG NO. -	REV -
Modified:	SCALE 1:1	-	SHEET 1 OF 1	

INFINIGAGE OPTICAL FORMAT DATA

InfiniGage		0.125x	0.25x	0.33x	0.50x	0.66x	0.75x	1.00x
	WD mm	286	155	120	85	72	67	52
	Mag	0.125	0.25	0.33	0.50	0.66	0.75	1.00
	FOV 1/2"	51.2	25.6	19.4	12.8	9.7	8.5	6.4
	FOV 1/3"	38.4	19.2	14.5	9.6	7.3	6.4	4.8
2x Amplifier	WD mm	286	155	120	85	72	67	52
	Mag	0.25	0.50	0.66	1.00	1.32	1.50	2.00
	FOV 1/2"	25.6	12.8	9.7	6.4	4.8	4.3	3.2
	FOV 1/3"	19.2	9.6	7.3	4.8	3.6	3.2	2.4

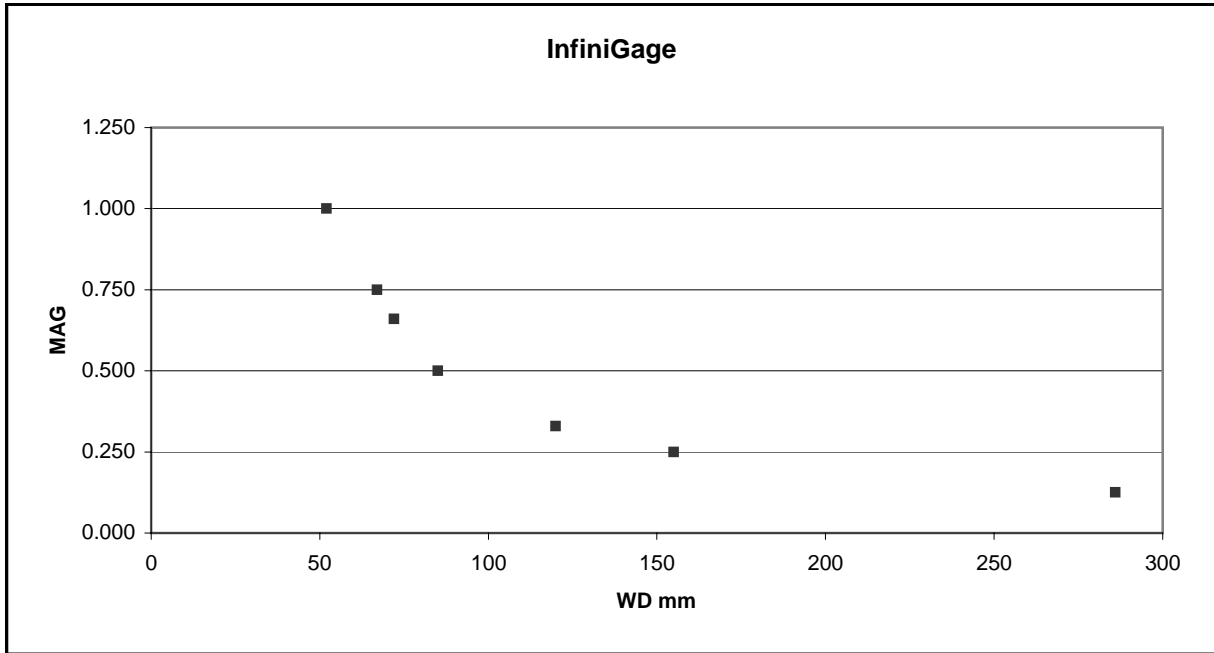

INFINIGAGE OPTICAL RESOLUTION DATA AT 550nm

InfiniGage		0.125x	0.25x	0.33x	0.50x	0.66x	0.75x	1.00x
	WD mm	286	155	120	85	72	67	52
	Mag	0.125	0.25	0.33	0.50	0.66	0.75	1.00
	NA	0.007	0.012	0.016	0.022	0.026	0.028	0.037
	Resolution (lines/mm)	20	37	48	67	79	85	110
	DOF mm	12.5	3.7	2.2	1.1	0.8	0.7	0.4

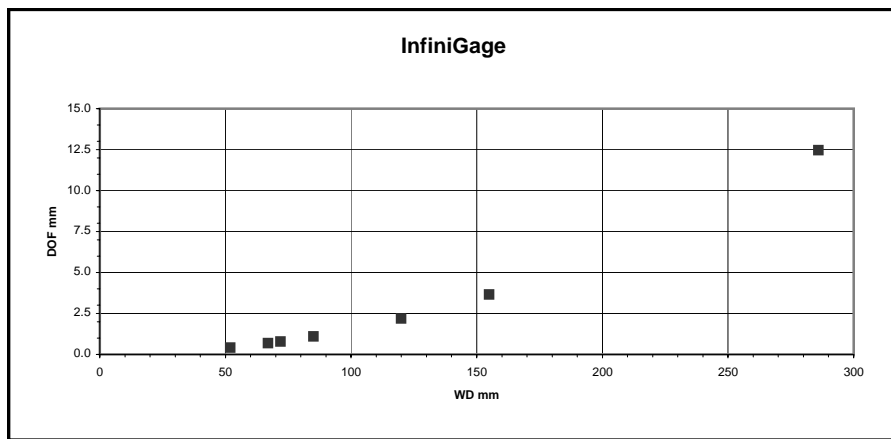
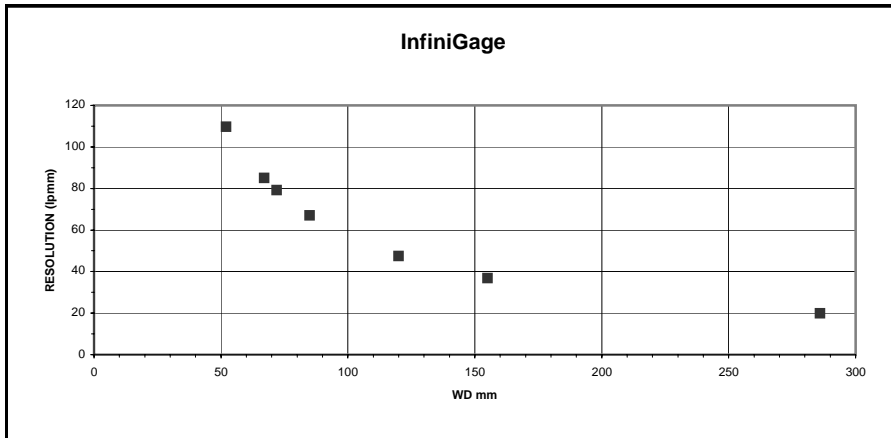
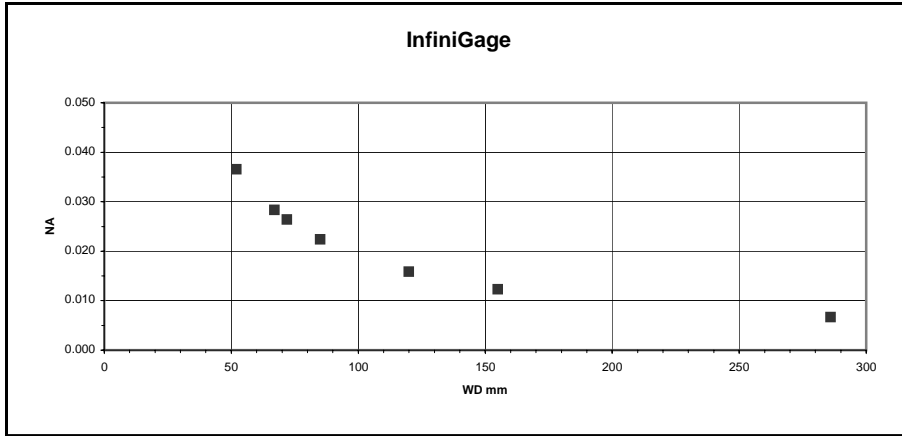

INFINIGAGE UV OPTICAL RESOLUTION DATA AT 340nm

InfiniGage UV		0.125x	0.25x	0.33x	0.50x	0.66x	0.75x	1.00x
	WD mm	286	155	120	85	72	67	52
	Mag	0.125	0.25	0.33	0.50	0.66	0.75	1.00
	NA	0.007	0.012	0.016	0.022	0.026	0.028	0.037
	Resolution (lines/mm)	32	59	77	108	128	138	177
	DOF mm	7.7	2.3	1.4	0.7	0.5	0.4	0.3

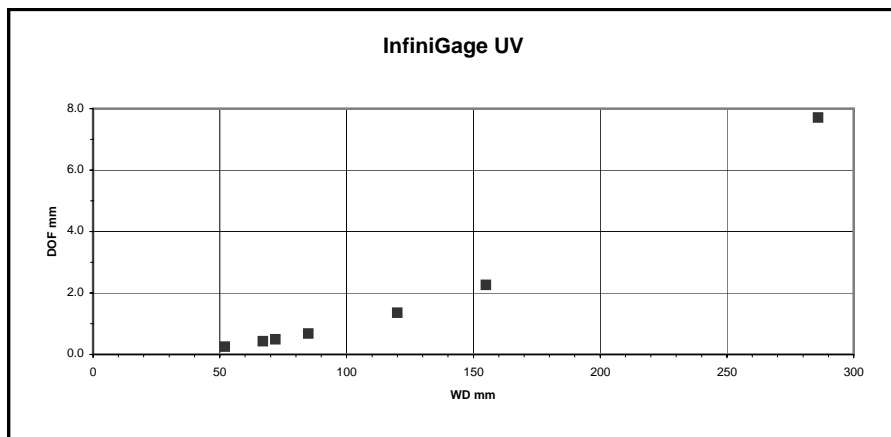
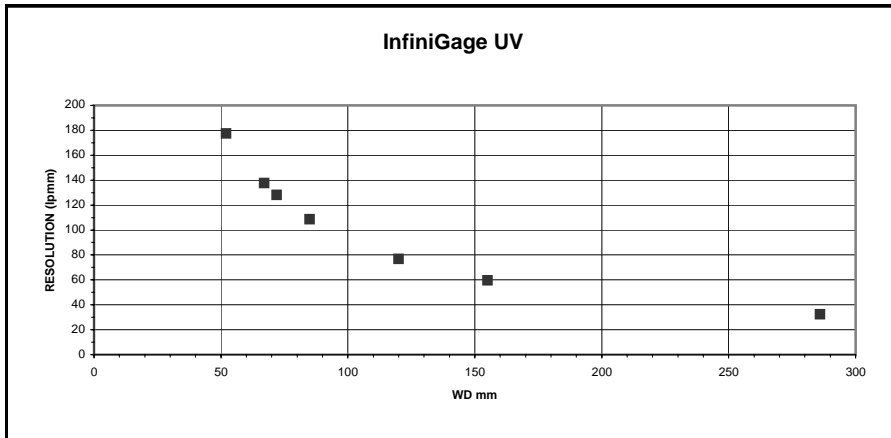
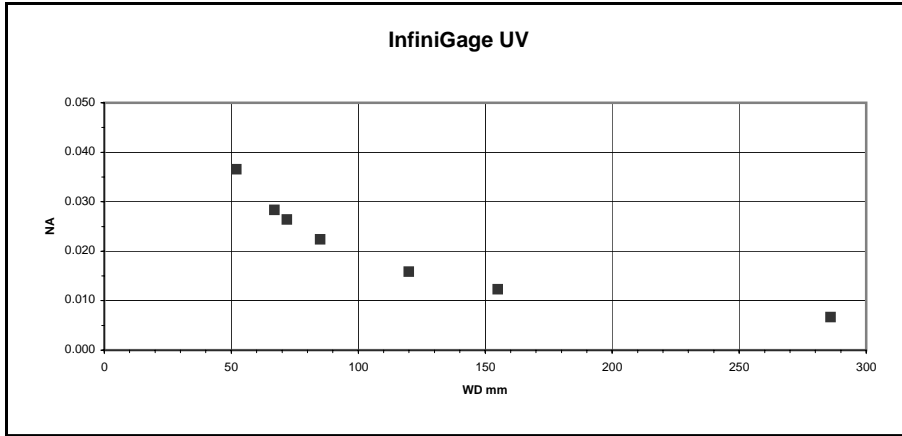

INFINIGAGE CW OPTICAL FORMAT DATA

InfiniGage		0.28x	0.50x	0.75x	0.90x	1.10x	1.25x	1.60x
	WD mm	95	56	39	34	29	26	23
	Mag	0.280	0.50	0.75	0.90	1.10	1.25	1.60
	FOV 1/2"	22.9	12.8	8.5	7.1	5.8	5.1	4.0
	FOV 1/3"	17.1	9.6	6.4	5.3	4.4	3.8	3.0
2x Amplifier	WD mm	95	56	39	34	29	26	23
	Mag	0.56	1.00	1.50	1.80	2.20	2.50	3.20
	FOV 1/2"	11.4	6.4	4.3	3.6	2.9	2.6	2.0
	FOV 1/3"	8.6	4.8	3.2	2.7	2.2	1.9	1.5

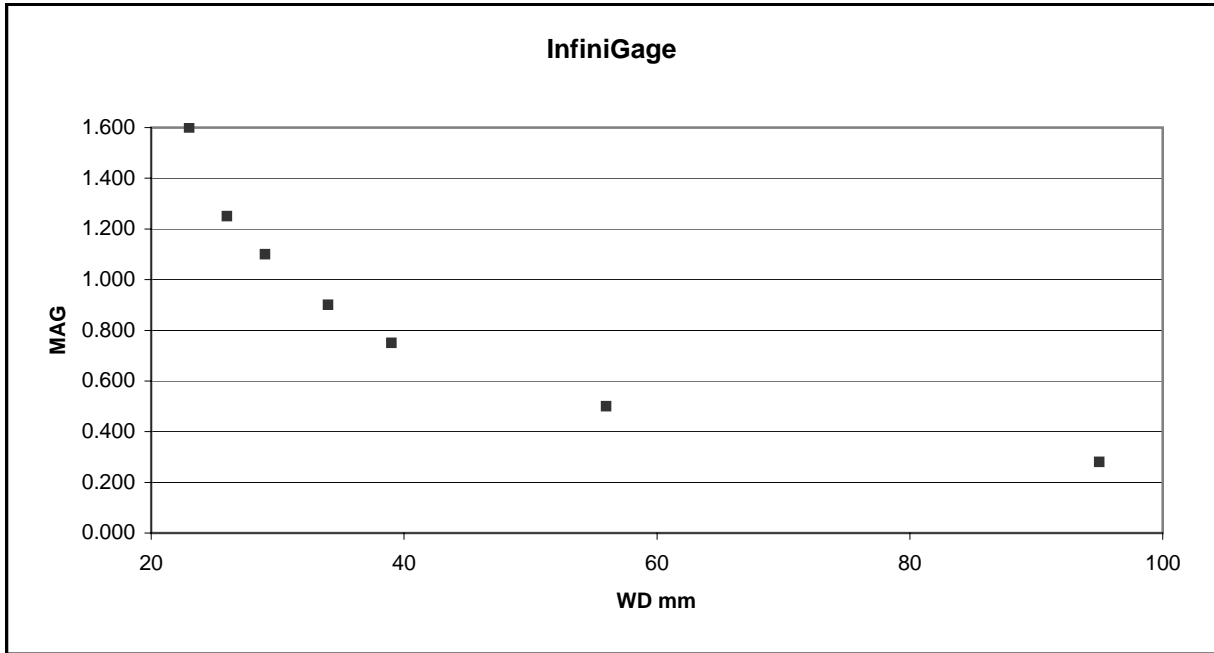

INFINIGAGE CW OPTICAL RESOLUTION DATA AT 550nm

InfiniGage CW		0.28x	0.5x	0.75x	0.90x	1.1x	1.25x	1.60x
	WD mm	95	56	39	34	29	26	23
	Mag	0.28	0.50	0.75	0.90	1.10	1.25	1.60
	NA	0.017	0.029	0.041	0.047	0.055	0.062	0.070
	Resolution (lines/mm)	51	86	123	141	166	185	209
	DOF mm	1.94	0.67	0.33	0.25	0.18	0.14	0.11

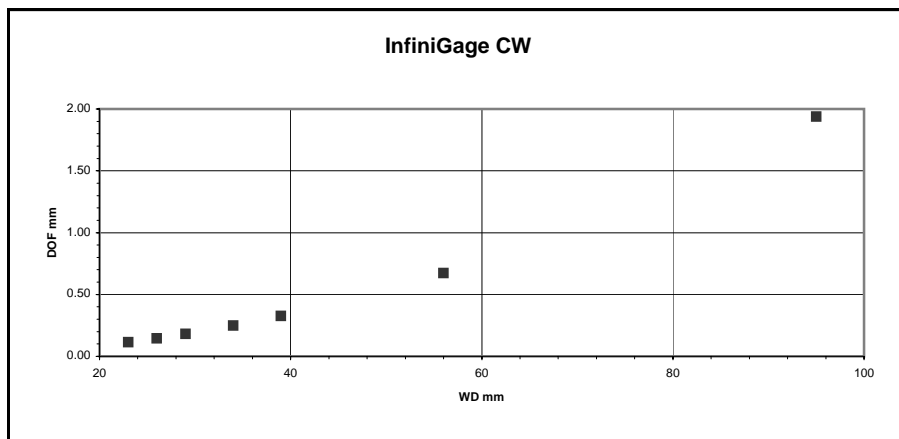
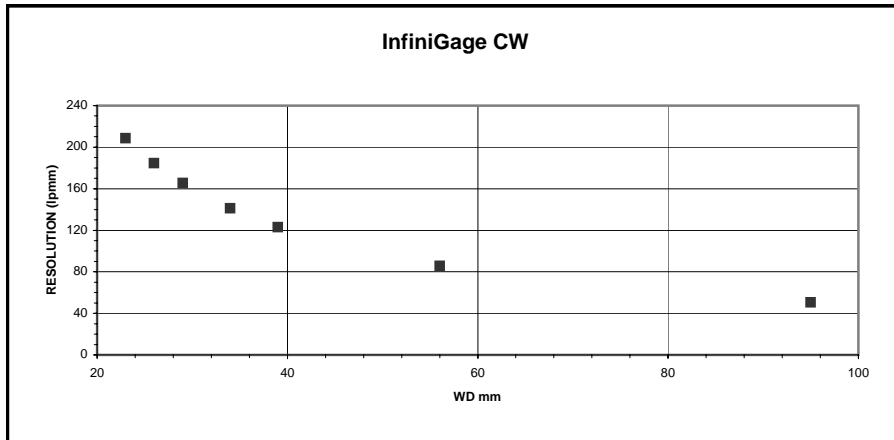
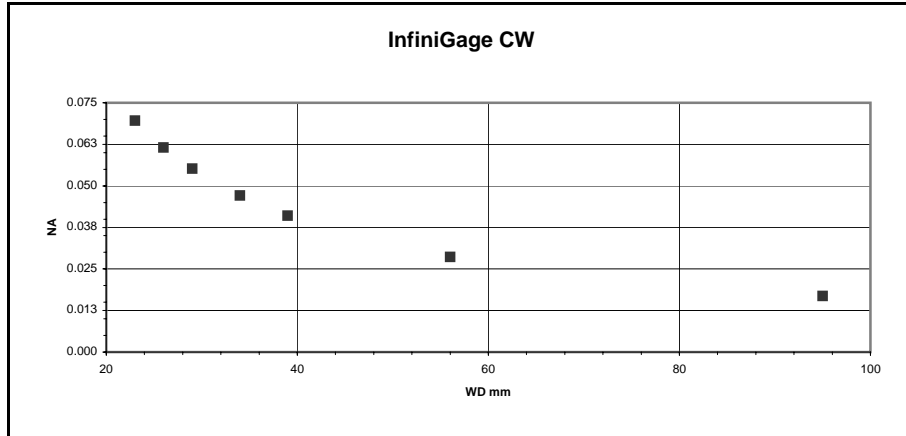

REVISIONS				
ZONE	REV	DESCRIPTION	DATE	APPROVED

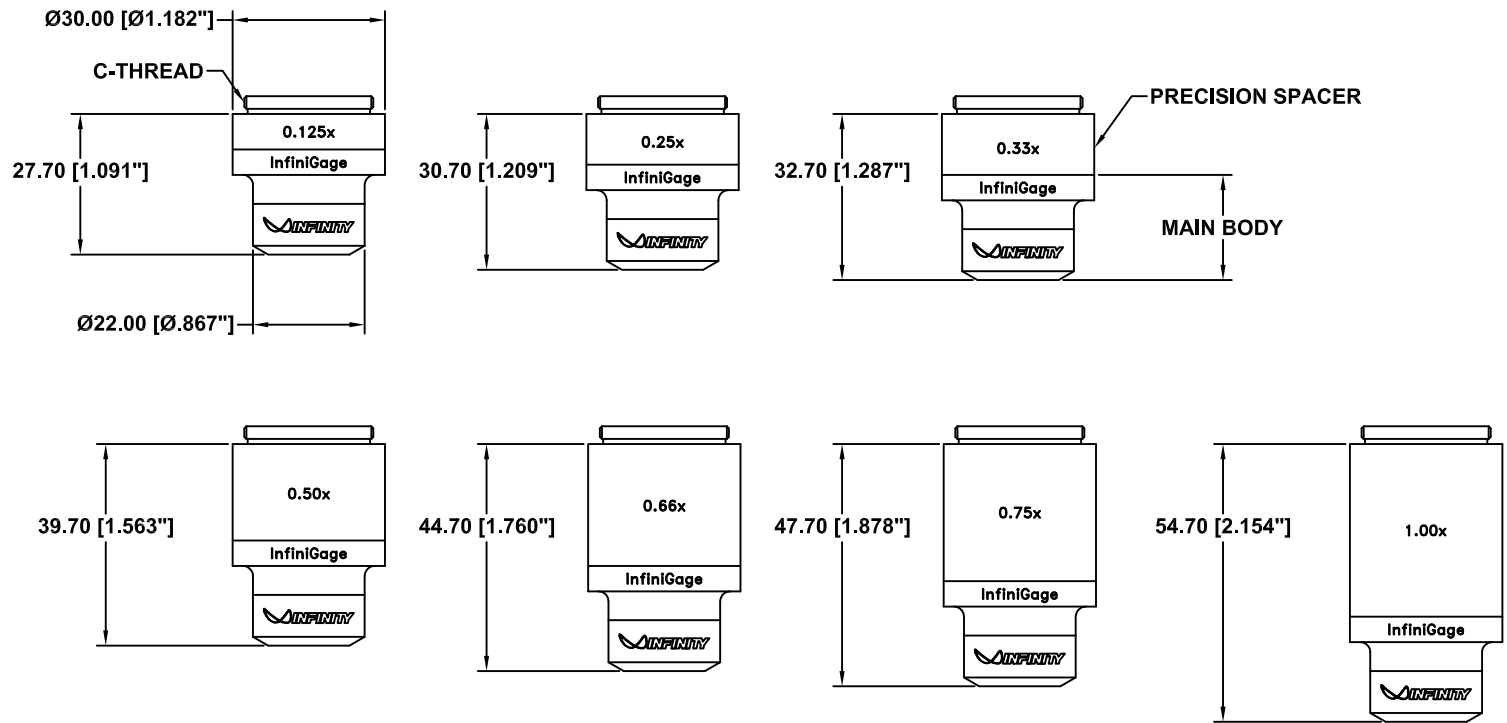

This drawing is for informational purposes only. No other rights or privileges are granted or implied.

ALL DIM ARE mm [inches] AND ARE FOR REFERENCE ONLY AND ARE SUBJECT TO CHANGE.		INFINITY Photo-Optical Company www.infinity-usa.com		
		INFINIGAGE MAIN LENS BODY AND PRECISION SPACERS		
Date: 10/05/04 MB	SIZE B	FSCM NO.	DWG NO. -	REV -
Modified:	SCALE NONE	-	SHEET 1 OF 1	

REVISIONS				
ZONE	REV	DESCRIPTION	DATE	APPROVED

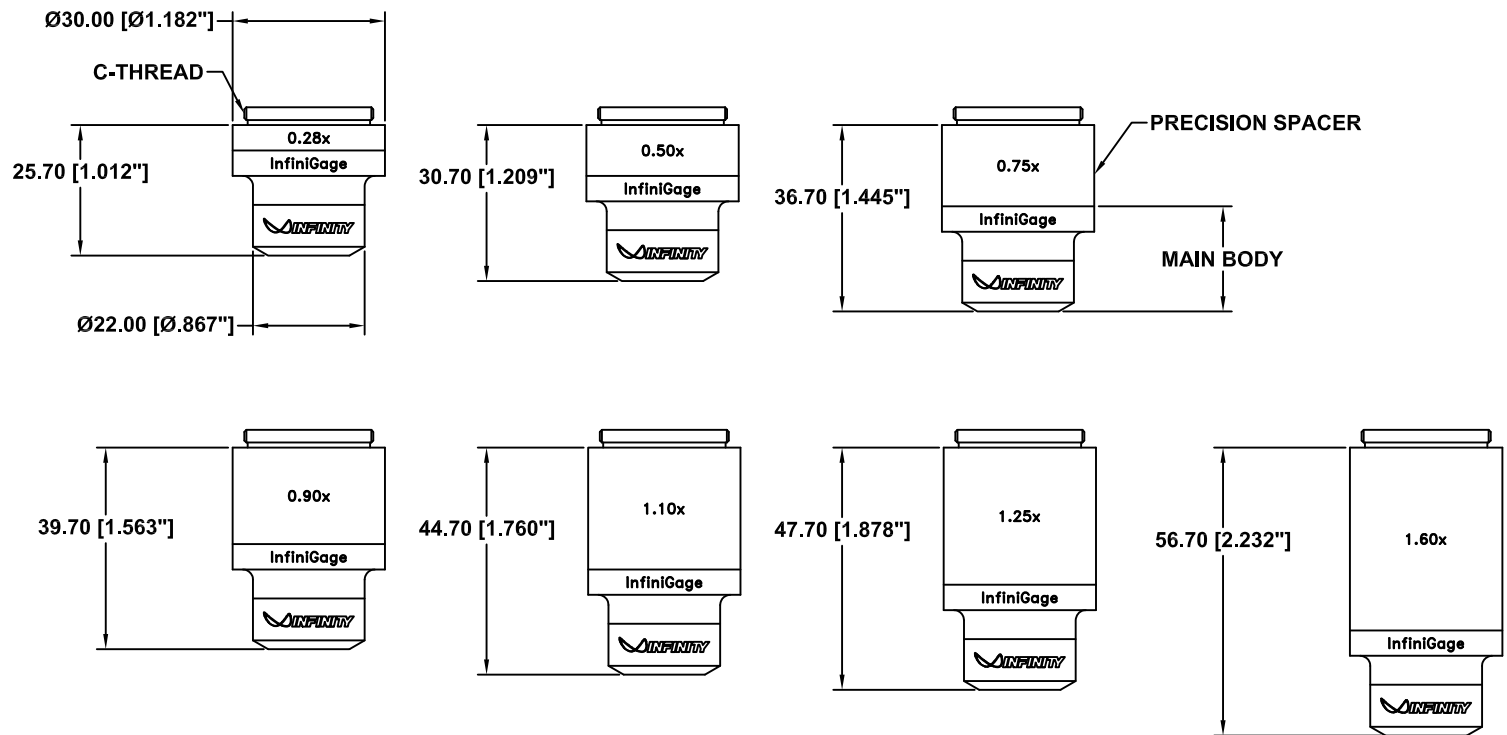

This drawing is for informational purposes only. No other rights or privileges are granted or implied.

ALL DIM ARE mm [inches] AND ARE FOR REFERENCE ONLY AND ARE SUBJECT TO CHANGE.		INFINITY Photo-Optical Company www.infinity-usa.com		
Date: 05/13/09 MB		INFINIGAGE CW MAIN LENS BODY AND PRECISION SPACERS		
Modified:	SIZE B	FSCM NO.	DWG NO. -	REV -
	SCALE NONE		SHEET 1 OF 1	



REVISIONS				
ZONE	REV	DESCRIPTION	DATE	APPROVED

C-THREAD

OPTIONAL DL TUBE

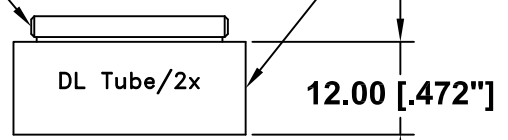

1/4"-20 AND
2x M4

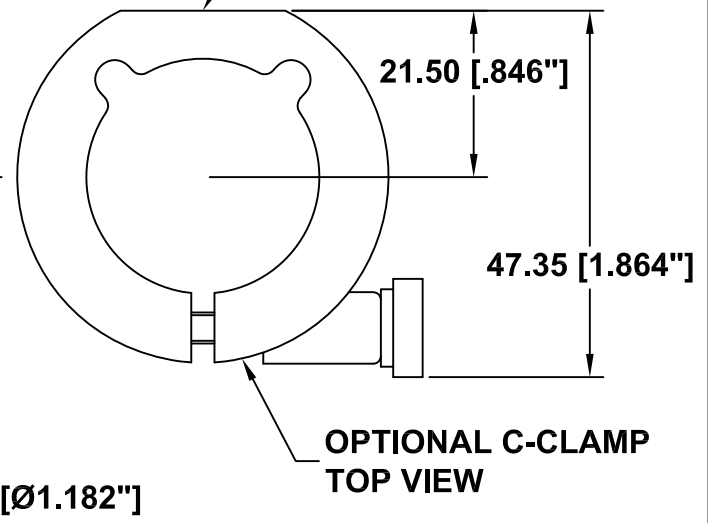

OPTIONAL C-CLAMP

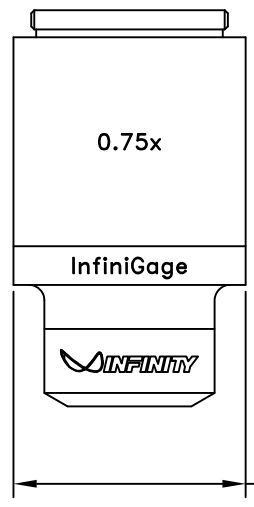
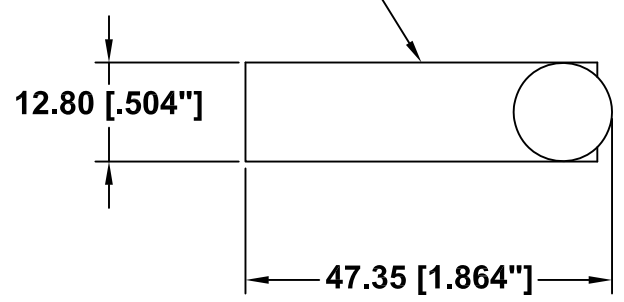

Ø30.00 [Ø1.182"]

This drawing is for informational purposes only. No other rights or privileges are granted or implied.

ALL DIM ARE mm [inches] AND ARE FOR REFERENCE ONLY AND ARE SUBJECT TO CHANGE.

INFINITY Photo-Optical Company
www.infinity-usa.com

INFINIGAGE OPTIONS

Date: 10/05/04 MB
Modified:

SIZE A	FSCM NO.	DWG NO. -	REV -
SCALE NONE	-	SHEET 1 OF 1	





REVISIONS				
ZONE	REV	DESCRIPTION	DATE	APPROVED

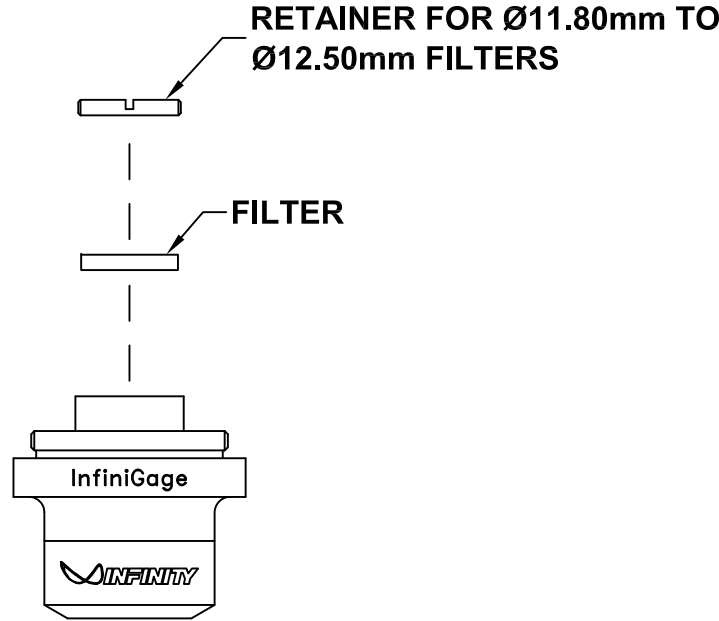

This drawing is for informational purposes only. No other rights or privileges are granted or implied.

ALL DIM ARE mm [inches] AND ARE FOR REFERENCE ONLY AND ARE SUBJECT TO CHANGE.

 **INFINITY** Photo-Optical Company
www.infinity-usa.com

INFINIGAGE FILTER INSTALLATION

Date: 10/05/04 MB
Modified:

SIZE A	FSCM NO.	DWG NO. -	REV -
SCALE NONE	-	SHEET 1 OF 1	



INFINITY PHOTO-OPTICAL COMPANY LIMITED WARRANTY

INFINITY PHOTO-OPTICAL COMPANY hereby warrants its products to be free from defects in workmanship or materials for the warranty period set forth below. INFINITY PHOTO-OPTICAL COMPANY, at its option, shall repair or replace the defective product without cost to the purchaser, and such repair or replacement shall be the full extent of this express limited warranty. INFINITY PHOTO-OPTICAL COMPANY shall not be liable for any other damages either direct or consequential.

This warranty is made to the original purchaser, and is effective only on new equipment purchased from INFINITY PHOTO-OPTICAL COMPANY, or a dealer authorized by INFINITY PHOTO-OPTICAL COMPANY to sell the product.

This warranty is valid only when the product is returned to the authorized dealer from whom it was purchased, or returned directly to INFINITY PHOTO-OPTICAL COMPANY, freight prepaid, with proof of date of purchase.

This warranty does not extend to any defect, malfunction or failure caused by misuse, abuse or the use of the product with equipment for which it may not have been intended. Any unauthorized repair voids this warranty.

The warranty period for all products manufactured by INFINITY PHOTO-OPTICAL COMPANY is five (5) years from date of original purchase. Parts or components made or sourced from other manufacturers shall be solely covered by that manufacturer's warranty.

The warranty contained herein is the only warranty made by INFINITY PHOTO-OPTICAL COMPANY. Any implied warranty of merchantability and/or fitness for a particular purpose is expressly excluded from this warranty. INFINITY PHOTO-OPTICAL COMPANY shall not be liable for any expense, loss, incidental or consequential damages which may arise in connection with the use of this equipment. Recovery under this warranty is limited to repair or replacement of the equipment as provided above.

INFINITY PHOTO-OPTICAL COMPANY reserves the right to modify designs, equipment and accessories without notice.

RETURNING INFINITY PRODUCTS FOR SERVICE

Warranty Repairs:

If you have reason to think something is wrong or functioning improperly with your Infinity Photo-Optical product under the terms of the Warranty, please contact us to explain the problem. We can not accept items sent to us without first discussing the problem and providing you with a return merchandise authorization (RMA). Customer is responsible for delivery charges to us. We will examine the product and inform you whether or not the Warranty applies. If so, we will repair/replace the item to factory specifications free of charge. Return delivery charges will be paid by us. If the item(s) is/are deemed out of Warranty, we will advise if repairs can be made at a quoted charge. If customer refuses to authorize a charged repair, item will be returned at the customer's expense.

Repairs of Out of Warranty Products:

Often, we get requests to fix or repair products which are clearly older models out of Warranty. Before attempting to send such to us, please contact Infinity to go over what is desired. It is helpful to send us photos of the product so that we can see if there is a reasonable basis for a repair. Often, older instruments are "inherited" in a department and may have been tampered with by previous users. Infinity products obtained second-hand may have missing parts. After obtaining an RMA as detailed above for Warranty repairs, we will examine the item(s) and provide you with an estimate of charges for repair and return delivery to a level of performance agreed upon. Sometimes it is not possible to cost-effectively repair a product that has been abused or disassembled. A slight cosmetic defect may not affect performance and if so, we will not repair or replace it unless instructed to do so at additional charges. Upon your authorization for us to perform the repair, you will be charged at the price previously quoted for the service and delivery charges involved.